

DIR9200-8/10/12 Drop-In Rack



Front View



Rear View



PDYZ35 Podium + DIR9200-12

DIR9200 drop-in racks are available in various capacities. Front EIA compliant racks in 3 sizes, 8U **DIR9200-8**, 10U **DIR9200-10** and 12U **DIR9200-12** units. These rack cubes can be pre-racked, dropped in on-site or secured to a wall or flat surface

Standard Features

- Powder coated, all steel construction
- EIA compliant, threaded rack rails (10-32 screws)
- Large top and bottom cable access openings
- Drop in design can be pre-racked
- Can be secured or fastened through bottom or side holes
- Ships knocked down with hardware (5 min assembly)

Specifications

Model: DIR9200-8/ DIR9200-10/ DIR9200-12
Height: 15-1/8" / 18-5/8" / 22-1/8"
Width: 19.25"
Depth: 18"
Finish: Black powder coat

Options

- **PB** Six outlet power bar with 10 ft. cord

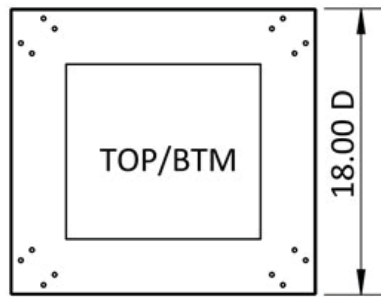

U	A	B
8U	15.13"	11.56"
10U	18.63"	14.06"
12U	22.13"	17.56"

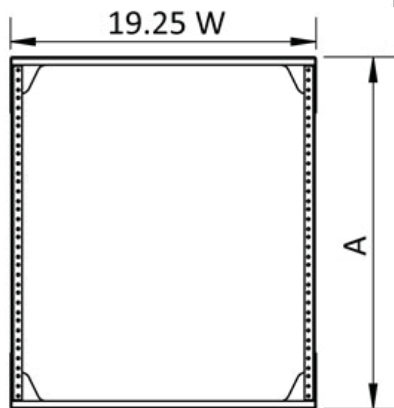

Front

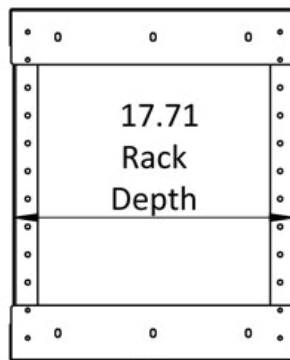

Side

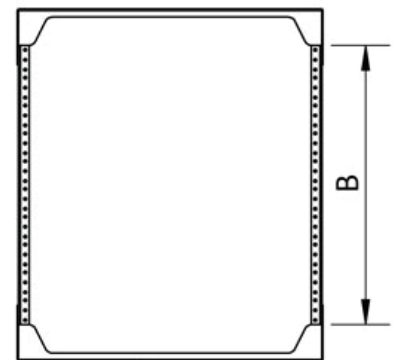

Rear

The information contained in this drawing is the sole property of Audio Visual Furniture International. Any reproduction in part or as a whole without the written permission of Audio Visual Furniture International is prohibited. We can build or modify stock configurations to suit customer specifications. Please contact us to discuss how this service can help meet your needs. Some quantity restrictions may apply. Specification subject to change without notice. Computers, cameras, monitors, etc. are shown to illustrate product usage and are not included unless otherwise noted.