

Date _____
 AVFI Sales REP _____
 Customer Signature _____

Quote No. _____
 Customer No. _____
 AVFI No. _____

Office Use Only

To generate your order form, please refer to the information provided below to insert the alphabetic and/or numeric code in the respective category boxes. Please note that without this filled out Order Form, your purchase **cannot** be processed.

1 Product Model	2 Top Option	3 Finish	4 Chargeable Accessories (One Code Per Box)	5 Custom Cutouts
PD51				

1 Product Model

Optional Tops



Code **PD51**
(Standard Configuration)

5101TP-L (Left Overhang)



5101TP-R (Right Overhang)



5102TP (Double Overhang)



2 Choose Product Finish

Standard Finishes (Ships within 1-15 business days)



Code **CJT**
(Crossfire Java)





Code **ELT**
(Elegance)





Code **EBT**
(Ebony)

Optional Finishes (Ships within 20 business days)

 **FMT**

 **HCT**

 **RCT**

 **CLT**

 **ART**

 **BRT**

 **CWT**

 **BAT**

 **SGT**

Comments (Please use this section to provide additional information)

Notes

CAD Drawings/Symbols
 CAD drawings are available by request at sales@vegroup.net

Custom Cutouts
 Estimated lead time within 20 business days from receipt of P.O. and signed drawings.

Customizations
 Modifications to design such as shape and/or size variations have to be quoted on a per case basis and are applicable for quantities of 10+ only.

2 Choose Top Option (Extra Charges Apply)

Code **C7** 5101TP-L (58" Left Overhang Worktop)
 Code **C8** 5101TP-R (58" Right Overhang Worktop)
 Code **C9** 5102TP (58" Double Overhang Worktop)

3 Chargeable Accessories (Check all that apply)

Code 00	No Accessories	
Code A4	SH-FL-51 Folding Side Shelf Kit.....	Qty _____
Code B1	9031-1 1U Utility Metal Shelf	Qty _____
Code B2	9031-2 2U Utility Metal Shelf	Qty _____
Code B3	9031-3 3U Utility Metal Shelf	Qty _____
Code B4	9041 Sliding Metal Shelf (Rear Rack Rail required)	Qty _____
Code B5	9052-2 2U Sliding Metal Drawer	Qty _____
Code B6	9052-3 3U Sliding Metal Drawer	Qty _____
* Code D1	MIC-18 MX418 S/C Microphone.....	Qty _____
* Code D2	LIGHT-18 Gooseneck Light	Qty _____
* Code D3	FM3 Timer/Clock	Qty _____
* Code E0	POP5 Power-Data Module	Qty _____
Code E1	PB 6 Outlet Power Bar	Qty _____
* Code E3	CUB3 Round Cable Well	Qty _____
* Code E4	SF-PB3 3 Outlet Power Bar	Qty _____
* Code E5	CUB5 Black Round Cable Well	Qty _____
* Code E6	CUB5 Silver Round Cable Well	Qty _____
* Code E7	PC-PATCH Power-Data Module	Qty _____
* Code E8	CUB8 Table Top Cable Well	Qty _____
* Code EA	CUB4S Silver Power Panel	Qty _____
* Code EB	CUB4B Black Power Panel	Qty _____
* Code EC	CHGQIW Wireless Charging Station White.....	Qty _____
* Code EF	CHGQIB Wireless Charging Station Black.....	Qty _____
* Code ED	CHGQI-DNGL Dongle Lightning.....	Qty _____
Code F9	5104TP Bridge Top	Qty _____
Code FA	5104DE Desk End (ADA Compliant).....	Qty _____
Code H6	RR14 14U Rack Rail Kit (Rear).....	Qty _____
Code J1	9107 Lacing Bar.....	Qty _____
Code J5	DIR9200-12 12U Rack Module.....	Qty _____
Code K1	C900S Single Monitor Arm.....	Qty _____
Code K3	PLM1022 Monitor Mount	Qty _____
Code K4	MM1232 Monitor Mount	Qty _____
Code M5	MCB1925 Monitor/Camera Bracket.....	Qty _____
Code Q1	LEV4AX4 4x Levelers for Non-Mobile Applications.....	Qty _____

* Cutout Required (Extra Charges will apply)
 ** Requires CHGQIW/B accessory § Only on Flat Cutout

Custom Cutout Option on Page 2

Please indicate custom cutout location on the drawing(s) below

5 Custom Cutout Option (Extra charges will apply)

PD51 - Standard Configuration

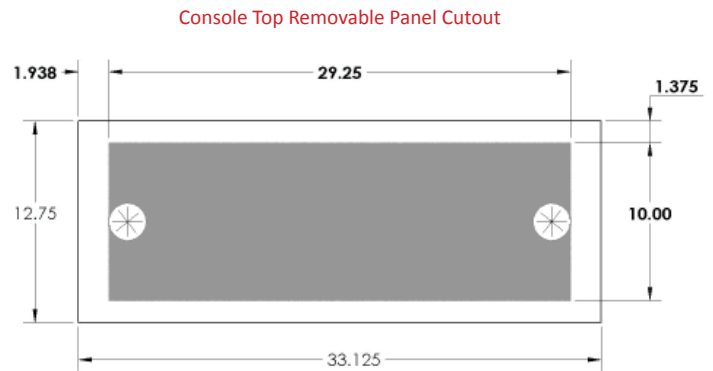
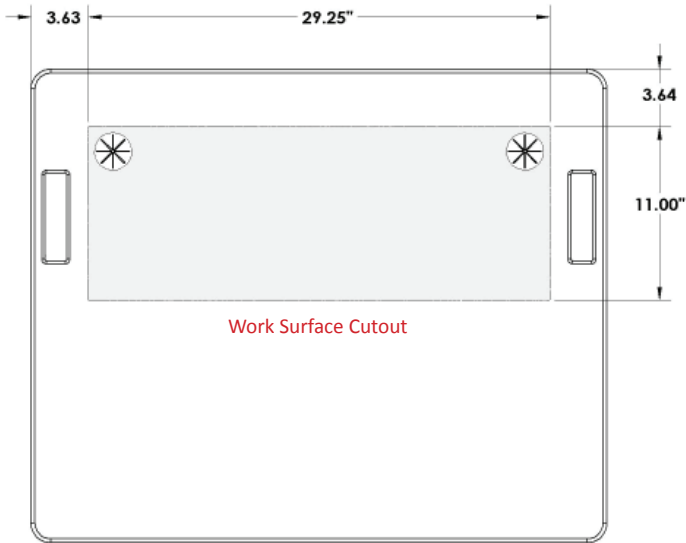

PD51 - Optional Worktops

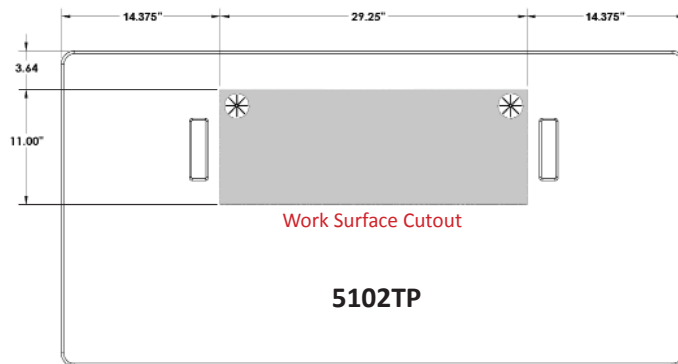
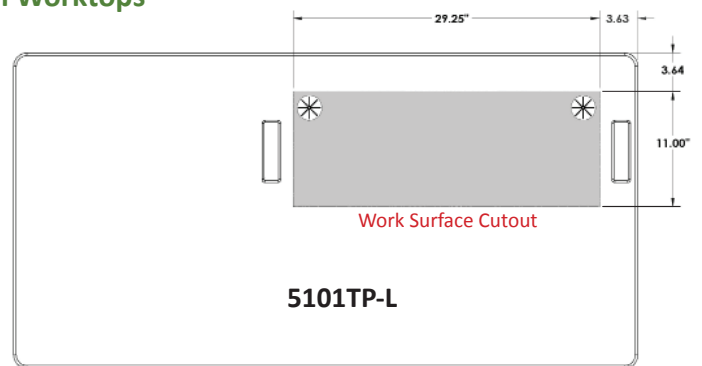
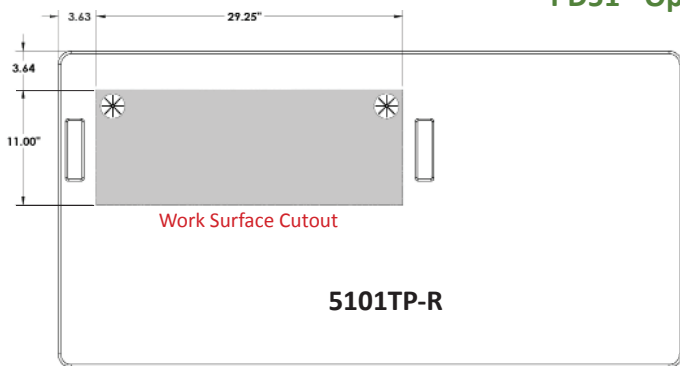

Code **CO** No Custom Cutout
 Code **CC** Custom Cutout (Specify on Cutout Area Above)

- Cutout Area - **Work Surface** (29.25"W X 11"D)
- Cutout Area - **Removable Console Top** (29.25"W X 10"D)
- Cutout Area - **Optional Worktop** (29.25"W X 11"D)